

#400006



Cell Culture Plate 6 well

 award 2018

6 well Plate 85.4×127.5mm PS, sterile
"plasma" growth area 9,6 cm², flat bottom
Non - pyrogenic
Non - cytotoxic
DNase/RNase/DNA - free
PS USP 6 SAL 10⁻⁶

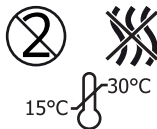

Scan for COA

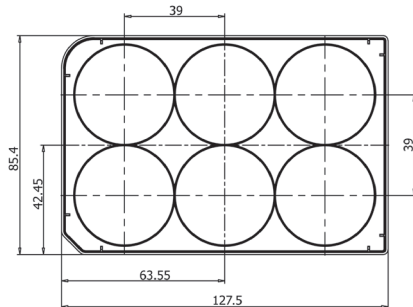

LOT
203/545442

EXP
6 Years

1 pc/bag

STERILE **R**

Bioswisstec Ltd. / e-mail : info@bioswisstec.com
website : bioswisstec.com / Schaffhausen, Switzerland

European Union Distribution /  Laboglob.com GmbH
e-mail : info@laboglob.com / website : laboglob.com
Gottmadingen, Germany